

Quadcept v10.7.0 Release Notes

Release Date 25th October 2022

メーカー一覧	品名	Manufacturer	Manufacturer Part	Description	Chip19top Part Num
すべて (216,938)	RT0805DRE0724K9L	Yageo	RT0805DRE0724	RES 24.9K OHM 1/4W 5-	
Altera (1,269)	RT1206FRE076159L	Yageo	RT1206FRE0761	RES 619 OHM 1/4W 1%	
Analog Devices Inc (7,704)	RT1206BRD07102KL	Yageo	RT1206BRD0710	RES 102K OHM 1/4W 1-	
Assmann WSW Components (64)	T5W-134-17-Q-D	Santec Inc	T5W-134-17-Q-D	CONN HEADER 68POS 1-	CL570100031852L
Abnet (1,437)	RT1206BRD07248L	Yageo	RT1206BRD0724	RES 2.80K OHM 1/4W 1-	
Analog Technologies US Inc (690)	RT1206BRD0780R6L	Yageo	RT1206BRD0780	RES 80.6 OHM 1/4W 1-	
AVX Corporation (211)	RT1206BRE0724K9L	Yageo	RT1206BRE0724	RES 24.9K OHM 1/4W 1-	
Bourns Inc (5,484)	RT1206CRD071478L	Yageo	RT1206CRD0714	RES 1.79K OHM 1/4W 2-	
Cree Inc (1,322)	RT1206CRD07523KL	Yageo	RT1206CRD0752	RES 523K OHM 1/4W 2-	
Diodes Incorporated (85)	RT1206CRE0716R6L	Yageo	RT1206CRE0716	RES 16.0 OHM 1/4W 25-	
Diodes Incorporated	RT1206CRD07380KL	Yageo	RT1206CRD0738	RES 380 OHM 1/4W 1-	
EPSON Inc	7432KL				
Fairchild Semiconductor	7449RL				
PCI	712R4L				

FREE

LTspice attributes

Quadcept has added about the **2,300** CAD component libraries from Toshiba Device & Storage to the "Quadcept Share library" with the cooperation of the company.

“Symbols” in Circuit design and “Footprint” in PCB design are pre-registered. Users can search for the parts from Quadcept and immediately proceed with design work.

© LTspice attributes included

▼ Added Categories

Comparator

Load Switch

MOSFET

Diode

Intellegent Power IC

NPN transistor

Opamp

eFuse

Optocoupler

PNP transistor

SiC SBD

LDO

Standard Logic

Transistor

TVS Diode

SSR

[Details here](#)

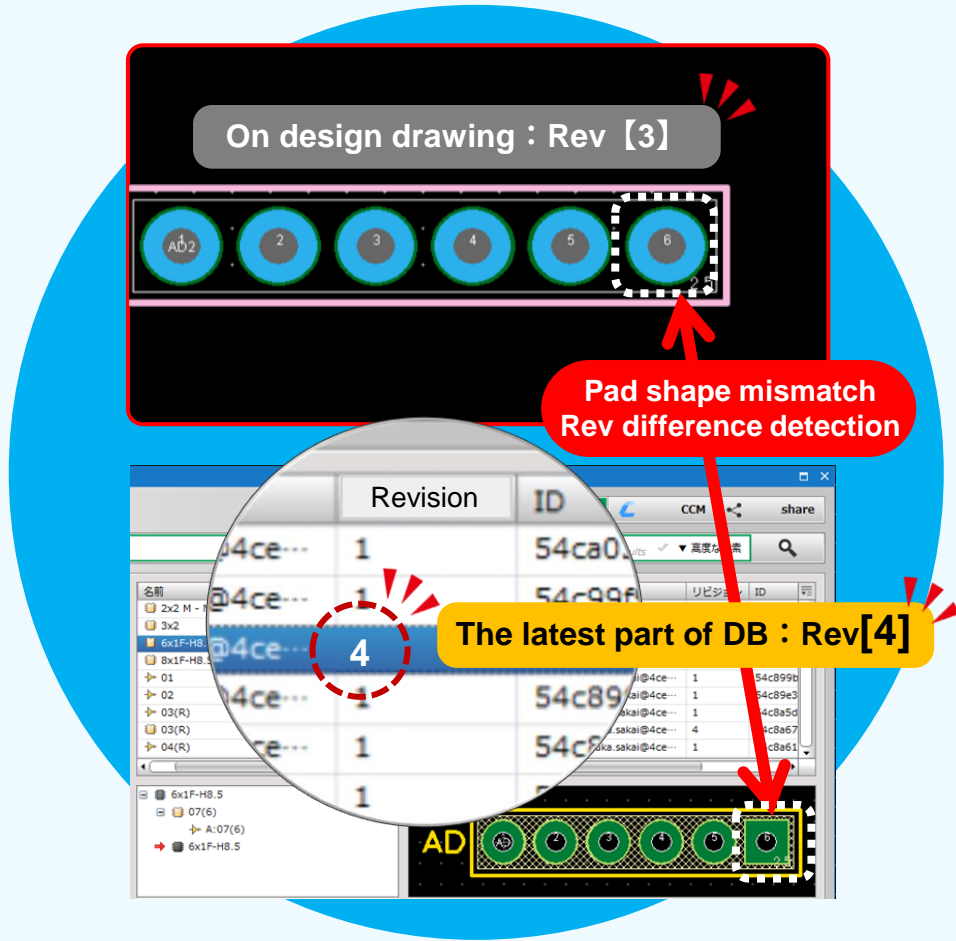

✔ Component Revision

The revisions of placed symbols / footprints can now be viewed and compared.

● Point

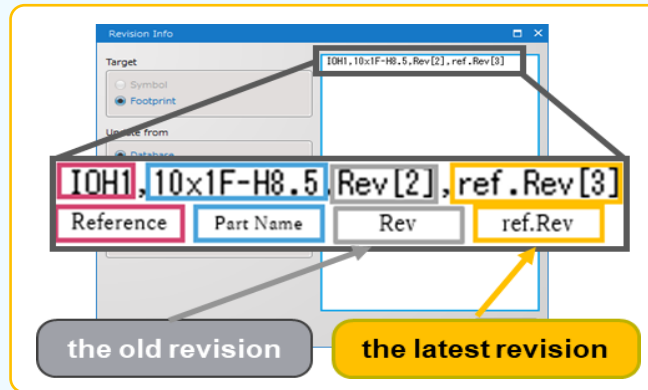

In case of a mismatch between the revision of a component placed in a drawing and the revision of one in the DB, they can now be listed and compared.

✔ Quadcept Force CCM

Quadcept Force CCM, our parts management system, can also enhance your development system.

● Point

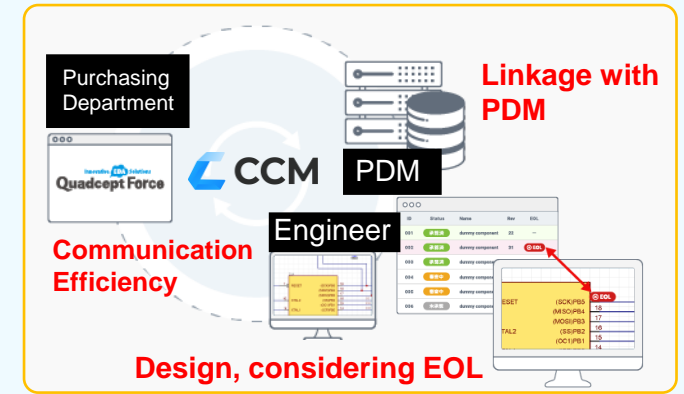

Quadcept Force CCM allows for part approval, rev management, and EOL management. In addition, PDM inventory information (stock/price, etc.) can be checked from the CAD screen when selecting parts, enabling design with less rework.

✔ Go directly to a destination.

Now possible to go directly to a port destination without Port Address List.

● Point

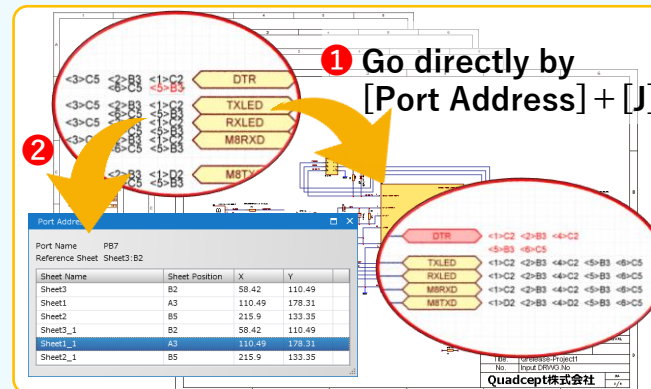

1 [Click Port Address] + [Shortcut Key : J]
Go directly to a port destination without Port Address List by clicking Port Address, then *Shortcut: "J".

2 *Shortcut: "Shift + J"
Display Port Address List by *Shortcut: "Shift + J"

✔ The display format flexible

Changed the display format of port addresses so that they can be separated on different lines or moved to desired locations.

● Before

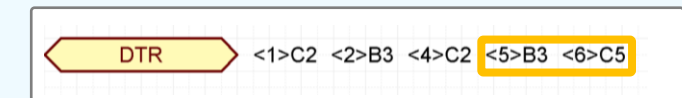

The format position was fixed to one line.

● After

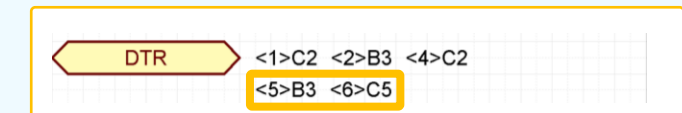

The format position is flexible.

✓ Create a thermal pad with a plane

Now possible to create a thermal pad with a plane. The net of a plane will be automatically set based on the net of the pad to which the plane is assigned.

• Before

Pin No.	Pin Name	Toggle Display	Electrical Cl
1	1	Show Pin + No.	Input
2	2	Show Pin + No.	Undefined
3	3	Show Pin + No.	Undefined
4	4	Show Pin + No.	Output
5	5	Show Pin + No.	Undefined
6	6	Show Pin + No.	Undefined
7	7	Show Pin + No.	Unused

Need to set "Unused"

Until now, a thermal pad was created with a pad or a filled polygon. However, an error was detected as "clearance".

• After

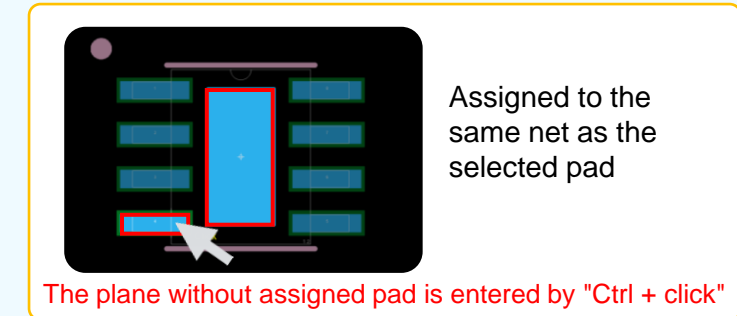

It is possible to create a thermal pad with a plane.

The net of a plane will be automatically set based on the net of the pad to which the plane is assigned.

✓ Automatically trim silkscreen

Create a new layer of silk trimmed with specified clearance values. The created silk can be edited on the PCB sheet.

• Before



It was necessary to manually cut silk.

• After



Duplicate the data to the "Silk_Auto" layer. The silk is cut based on certain rules.

< Note on manufacturing >

The "Silk_Auto" layer automatically generated by the silk-cutting function should be submitted to the manufacturing plant.

✓ Automatically trim silkscreen

Create a new layer of silk trimmed with specified clearance values. The created silk can be edited on the PCB sheet.

• Before



It was necessary to manually cut silk.

• After



Duplicate the data to the "Silk_Auto" layer. The silk is cut based on certain rules.

< Note on manufacturing >

The "Silk_Auto" layer automatically generated by the silk-cutting function should be submitted to the manufacturing plant.

✓ Automatically trim silkscreen

Create a new layer of silk trimmed with specified clearance values. The created silk can be edited on the PCB sheet.

• Before

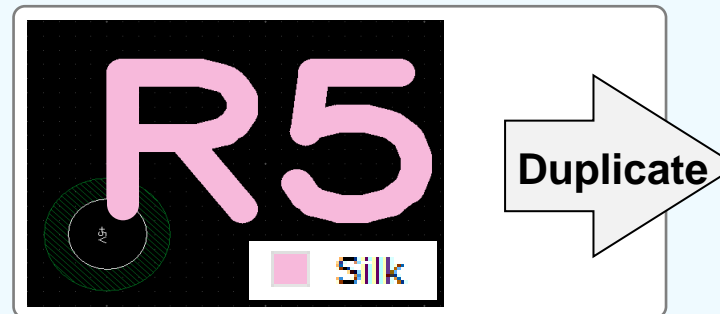

It was necessary to manually cut silk.

• After



Duplicate the data to the "Silk_Auto" layer. The silk is cut based on certain rules.

< Note on manufacturing >

The "Silk_Auto" layer automatically generated by the silk-cutting function should be submitted to the manufacturing plant.

Automatically Create Silk Data

✔ Set scale when importing DXF files

When you imported DXF files for complex board outlines, drilled holes, and other necessary information, the scale could not be changed, which required a lot of time and effort to manually resize it. We add the ability to set scale when importing DXF files into Quadcept.

● Before

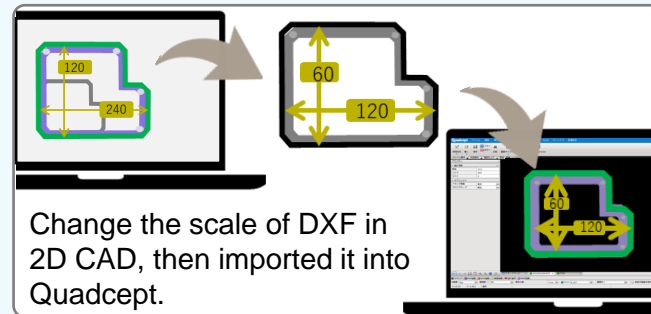

※ We have received a request to change the scale (double / half) such as when importing a logo.

● After

▼ Double scale

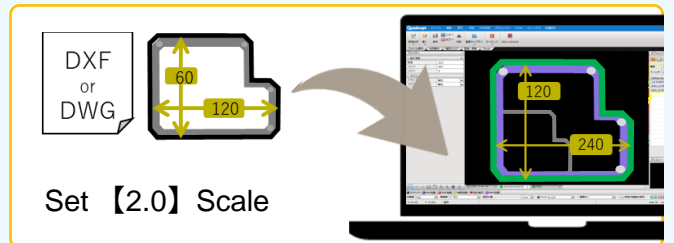

▼ Half scale

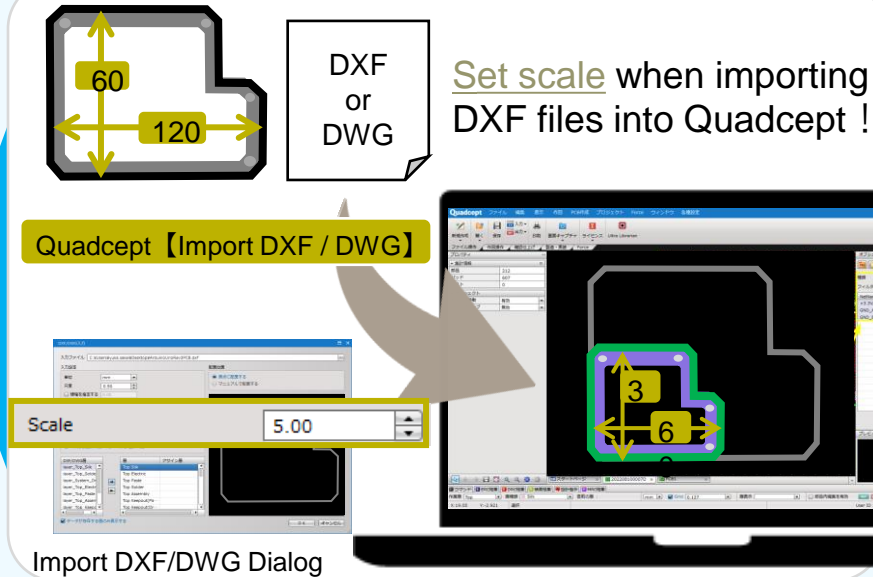
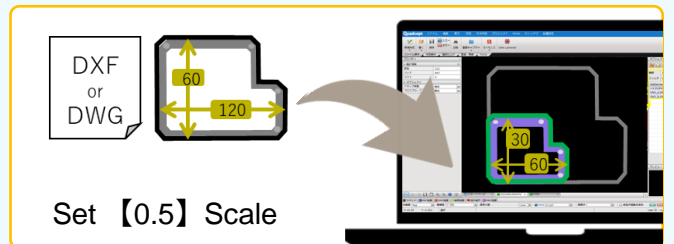

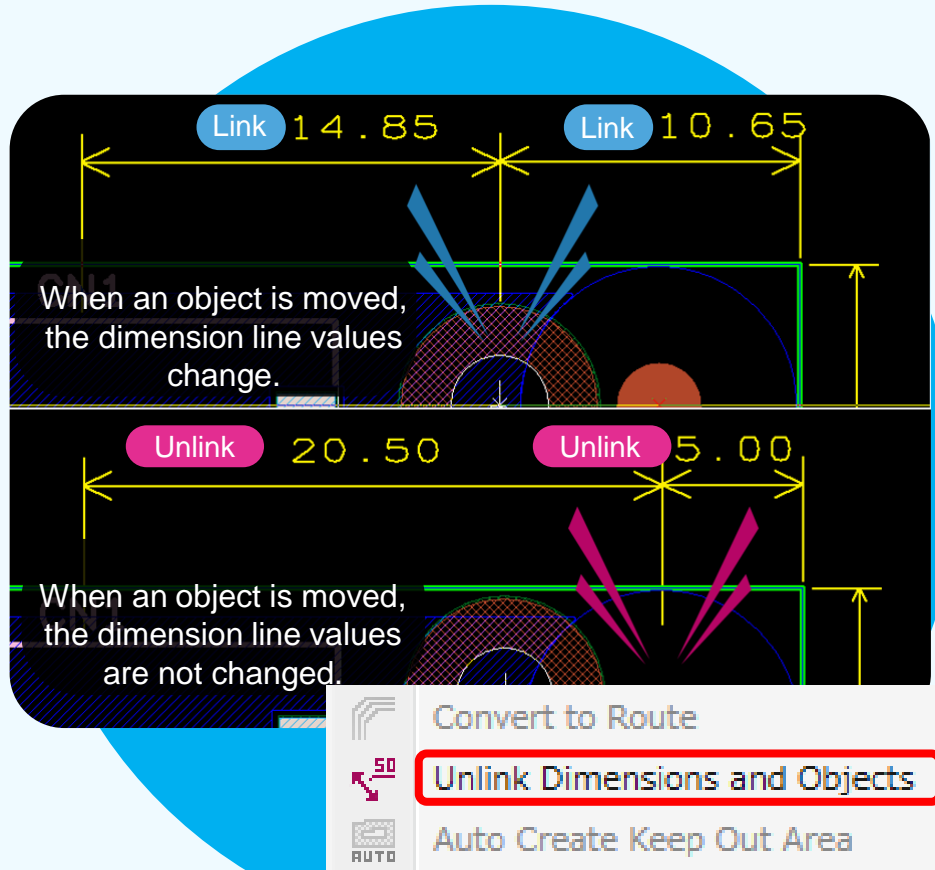

✓ Unlink Dimensions and Objects

Added the ability to break the links between dimension lines and their corresponding objects.

● Point

▼ Link Dimensions and Objects

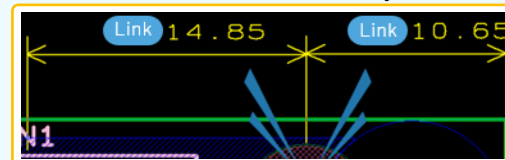

The ability to link (follow) dimension line values. When an object is moved, the dimension line values change.

▼ Unlink Dimensions and Objects

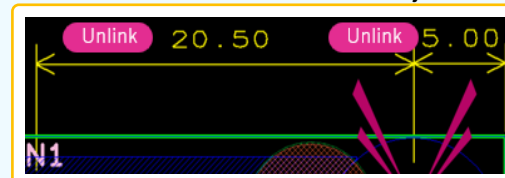

The ability to unlink (unfollow) dimension lines. When an object is moved, the dimension line values are not changed.

✓ Text set in a horizontal position

Added the ability to place text in a horizontal position while drawing dimension lines, which makes it easy to see drawings.

● Point

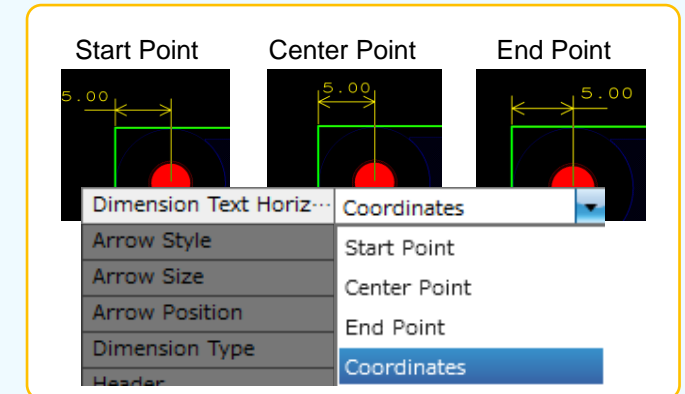

※ Possible to set just while drawing

- Improved reference leader lines for better viewing.
- Added the ability to output connection lines (rats nest) when printing a PCB sheet.
- Added the ability to import/export a component placement information file. This allows you to move multiple components at once via file import.
- Added references to components in STEP files to make it easier to identify components.

✓ The prohibited rules change, depending on the layers

The method of creating Keep Out Areas has been significantly changed to improve design work, which contributes to the merit of "visualization of each prohibited rule".

• Before

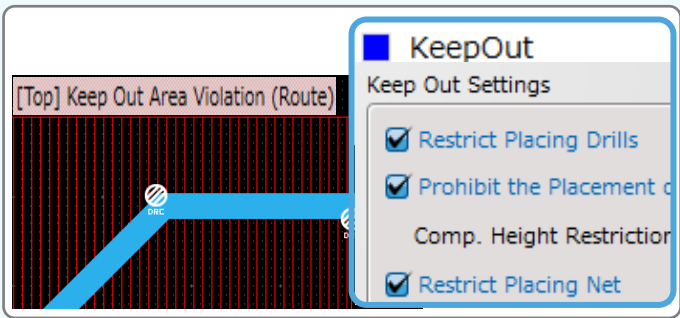

It was possible to set "3 prohibited rules; drill/parts/net" and "1 limit rule; Component Height" for one Keep Out Area.

However, since "fill color" and "fill style" could not be set for each prohibited rule, it was impossible to visually judge which rule was prohibited.

• After

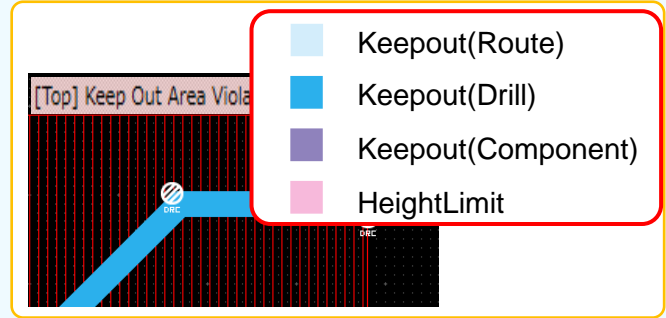

The prohibited rule depends on each Keepout Layer. That makes it possible to visually judge which rule is prohibited, because "fill color" and "fill style" can be set for each prohibited rule.

✘ When project data before v10.6 is opened in Quadcept v10.7 or later, the Keep Out Area is automatically generated in each Keepout layer.

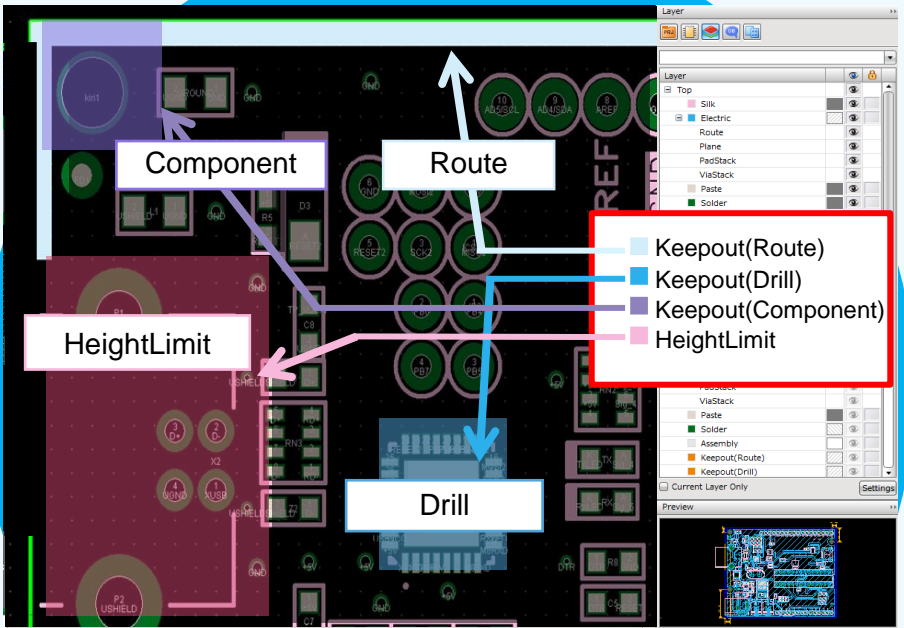

- Keepout(Route) ... Prohibit Route
- Keepout(Drill) ... Prohibit Drill
- Keepout(Component) ... Prohibit Component
- HeightLimit ... Limit Component Height

- ✔ Prevent false detection of errors
Revamped the behavior of the MRC clearance check to prevent false detection of errors.

- ✔ The last run date for Rule Check
The last run date for ERC/DRC/MRC can now be checked on the screen.

● Before

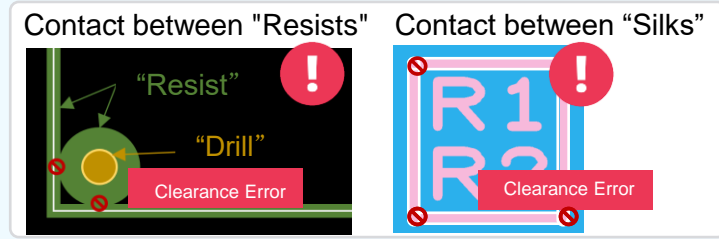

- After
Prevent false detection of errors.

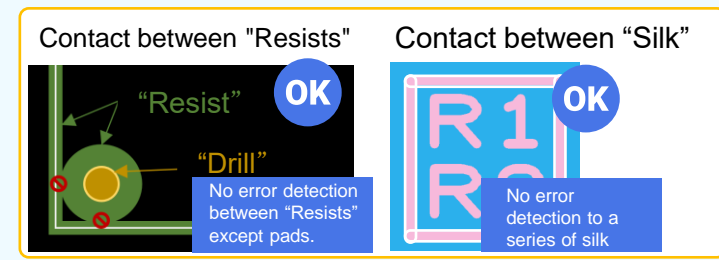

● Point

It is now easier to manage whether or not the check has been made after the correction.

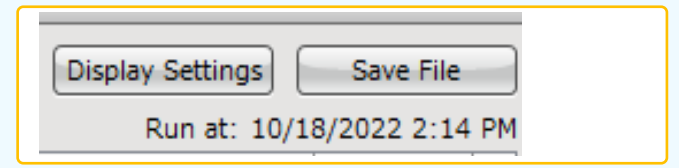

● Point

Check where the errors are from the entire design.

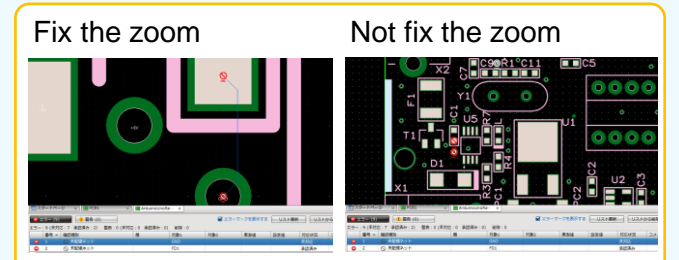

Enlarged view of the error area.

Thumbnail view of the error area.

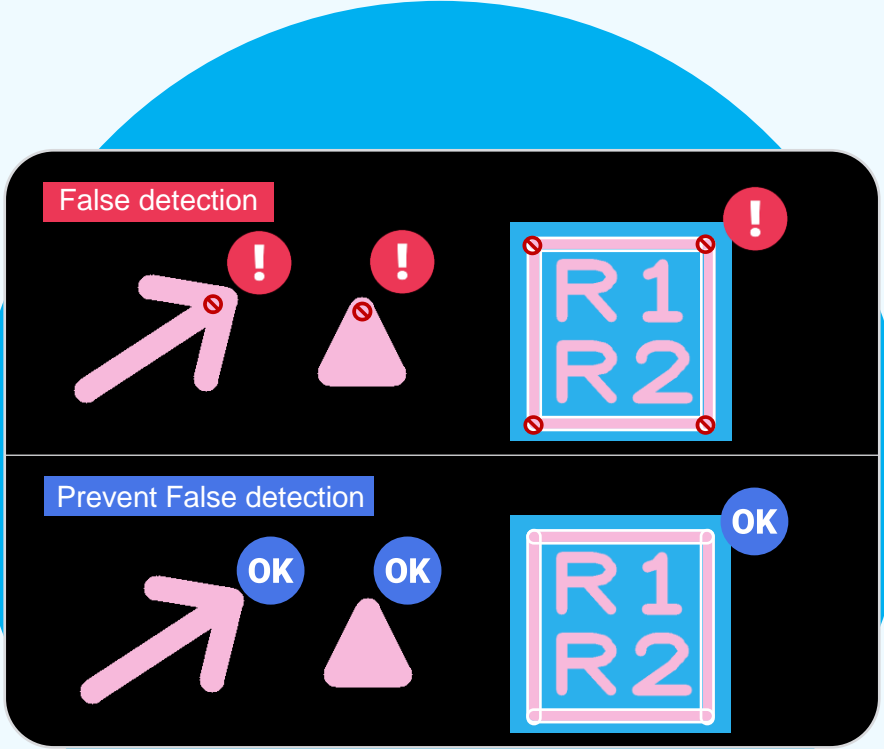

"Silk" in parts is also checked as MRC clearance.

※Due to revamping the judging criteria, the number of error judgments changes when past projects are opened and executed again.

✓ Set the Current Layer linked to the Display Layer Settings

Added the Current Layer setting to the Display Layer Settings. The specified layer will be displayed when the display layer setting is applied.

• Point

▼ Set the Current Layer linked to the Display Layer Settings.

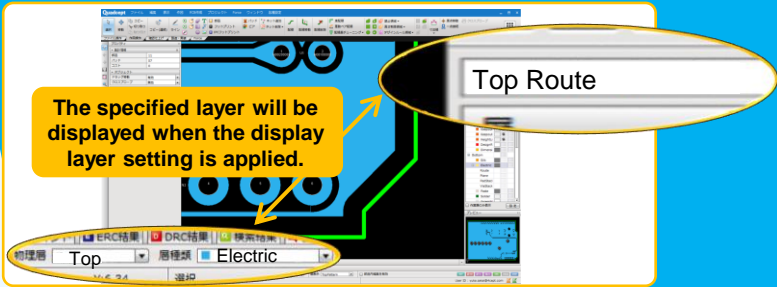

✓ Fix Line Width : ON/OFF

Added settings for both “the case where you want to maintain the line width for the next routing” and “the case where you do not want to maintain the line width for the next routing”. This makes routing more efficient.

• Point

▼ the case where you want to maintain the line

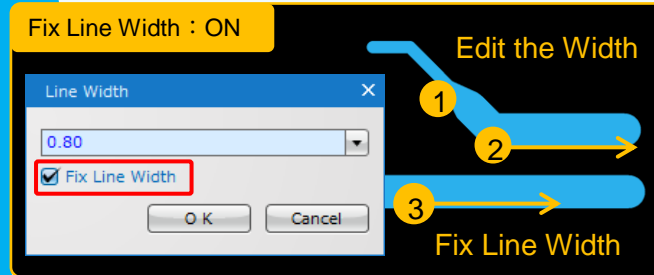

▼ the case where you don't want to maintain the line

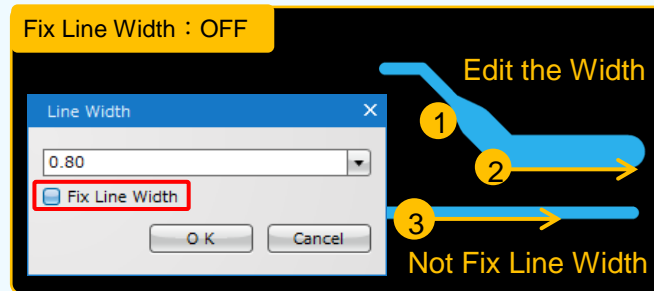

※Even if settings are changed during routing, the line width is fixed until the routing is completed.

✓ Added the ability to show/hide the outlines of dynamic planes

We received a request for ability to show/hide the outlines of dynamic planes.

• Point

▼ Drawing a Plane

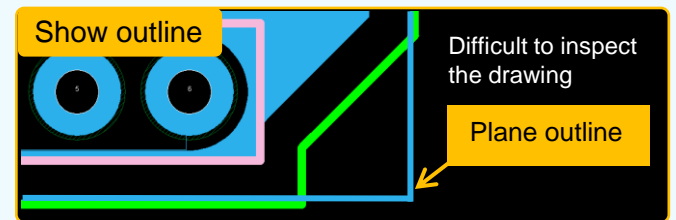

Drawing outlines are also visible.

▼ Inspecting Drawing

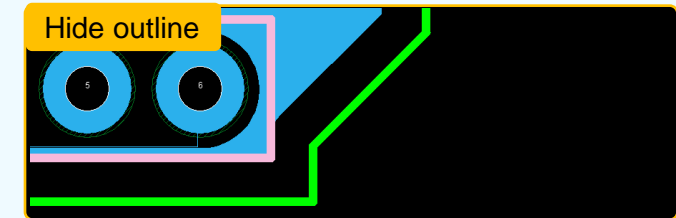

Hiding the outline, only just the plane is displayed.

- Added the Use Default button for the Run DRC/MRC dialog to easily reset the settings back to default.
- Added an alert message for output file names when exporting manufacturing data.
- Fixed the issues when importing DXF files.
 - Fixed an issue where certain splines would not be input correctly when importing DXF files.
 - Fixed an issue where oval shapes could not be input when importing DXF files.
- Revamped a panel area when placing a panel
 - Fixed an issue where a panel area was calculated including unnecessary objects.
- Fixed the issues of the Subtract command
 - Fixed an issue where teardrops were not covered by the Subtract command.

Approximately 50 other cases handled.

▶ [Details here](#)